



Installation instructions, accessories

Volvo Car Corporation Gothenburg, Sweden

Instruction No	Version	Part. No.
31359353	1.1	31359366, 31373455, 31373458, 31359368, 31373456, 31373766

Bumper bar, front bumper

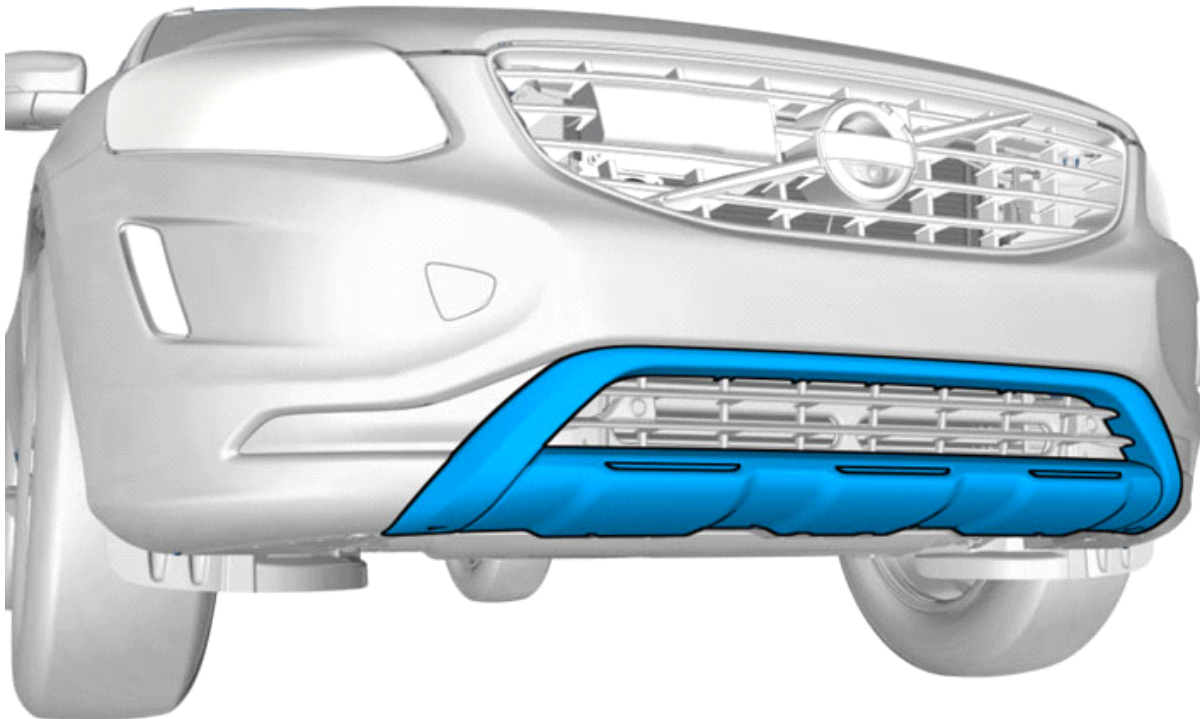

IMG-375145



Installation instructions, accessories

Volvo Car Corporation Gothenburg, Sweden

Materials

Designation	Part number
Isopropanol	1161721

Equipment

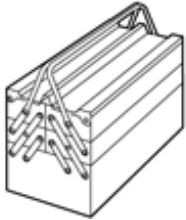

IMG-345497



IMG-239660

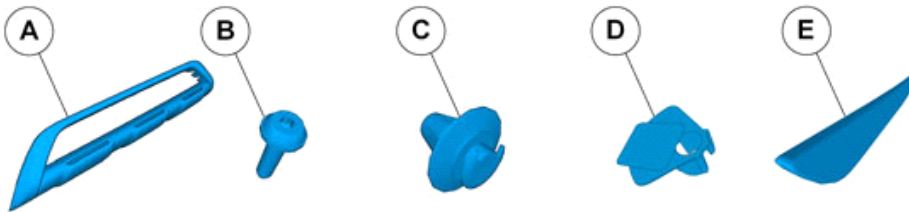

IMG-375166



Installation instructions, accessories

Volvo Car Corporation Gothenburg, Sweden

Information

1

Read through all of the instructions before starting installation.

Notifications and warning texts are for your safety and to minimise the risk of something breaking during installation.

Ensure that all tools stated in the instructions are available before starting installation.

Certain steps in the instructions are only presented in the form of images. Explanatory text is also given for more complicated steps.

In the event of any problems with the instructions or the accessory, contact your local Volvo dealer.

Further information

2

When installing, the car must retain a temperature of 20 degrees C.

Color symbols

3

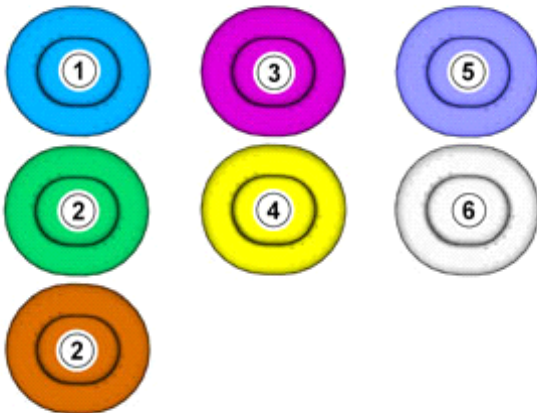

IMG-363036

Note!

This colour chart displays (in colour print and electronic version) the importance of the different colours used in the images of the method steps.

1. Used for focused component, the component with which you will do something.
2. Used as extra colors when you need to show or differentiate additional parts.
3. Used for attachments that are to be removed/installed. May be screws, clips, connectors, etc.
4. Used when the component is not fully removed from the vehicle but only hung to the side.
5. Used for standard tools and special tools.
6. Used when the component is not fully removed from the vehicle but only hung to the side.

Applies to unpainted component



Installation instructions, accessories

Volvo Car Corporation Gothenburg, Sweden

4

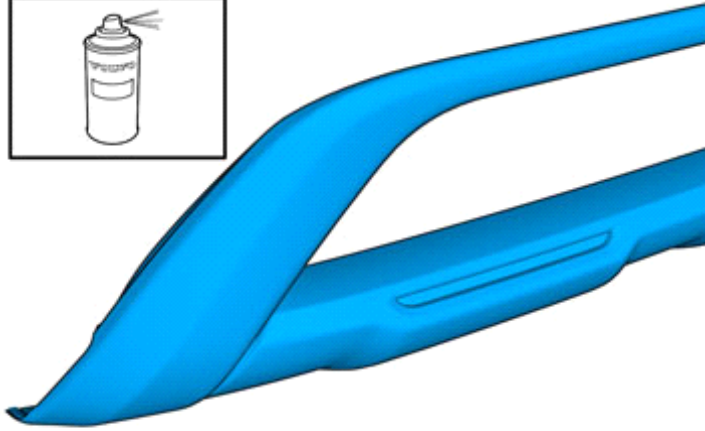

IMG-377449

5

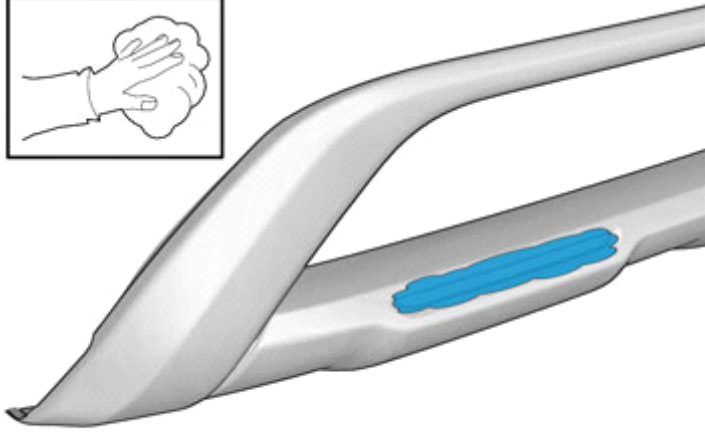

Caution!

First the paint must dry after painting.

Clean the surface.

Use: 1161721, Isopropanol

IMG-377450

6

Remove the protective film.

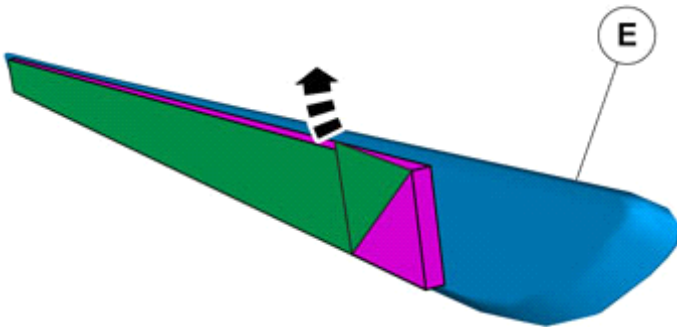

x3

IMG-377453



Installation instructions, accessories

Volvo Car Corporation Gothenburg, Sweden

7

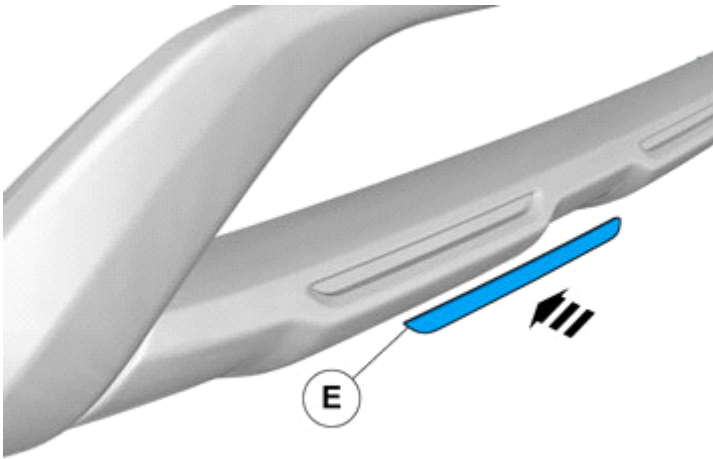

Install component that comes with the accessory kit.

IMG-377451

All vehicles

Removal

8

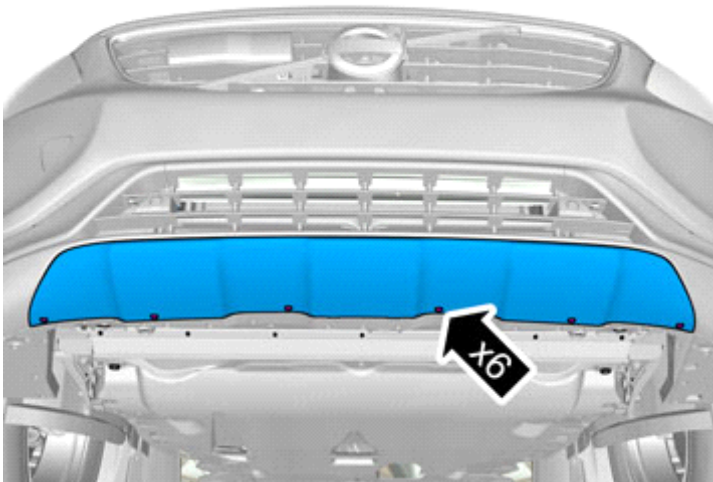

Remove the screws.

IMG-375159



Installation instructions, accessories

Volvo Car Corporation Gothenburg, Sweden

9

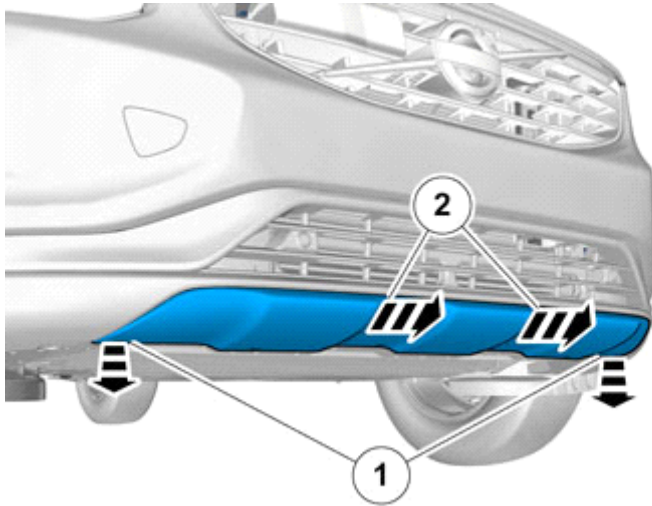

Remove the panel.

IMG-375160

Accessory installation

10

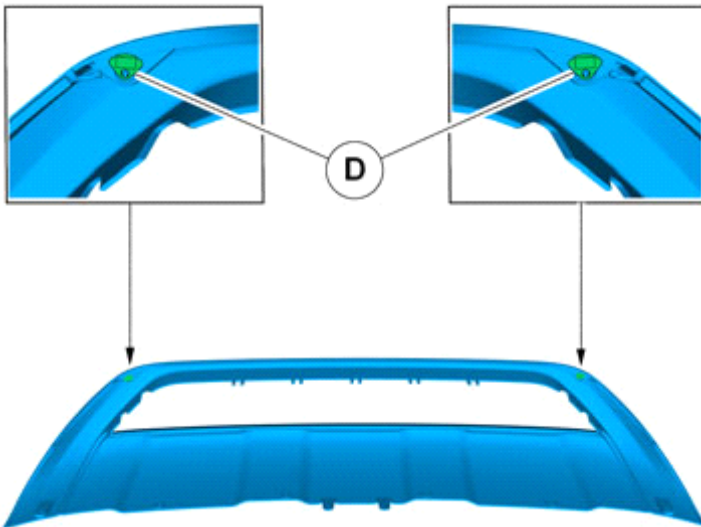

IMG-375199



Installation instructions, accessories

Volvo Car Corporation Gothenburg, Sweden

11

Remove the protective film.

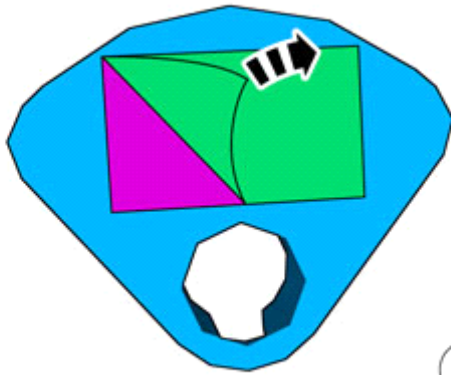

D x2

IMG-375204

12

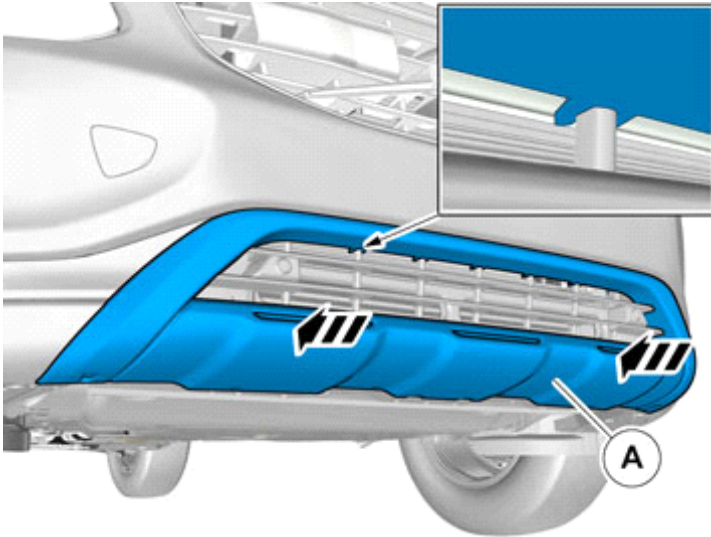

IMG-375162

13

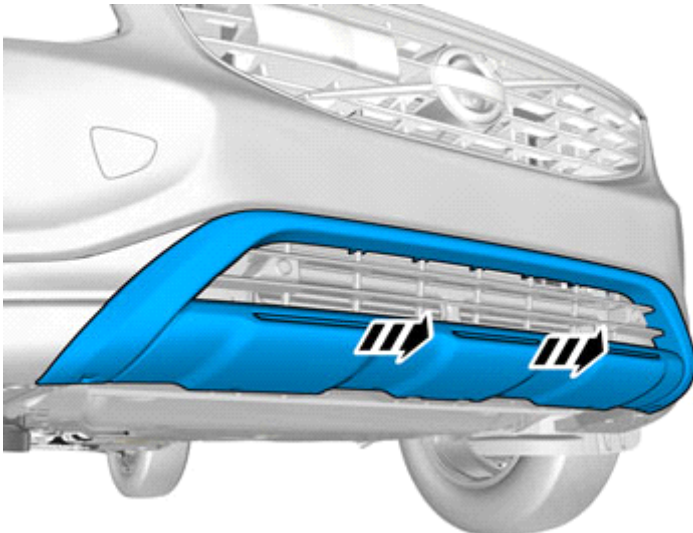

IMG-375206



Installation instructions, accessories

Volvo Car Corporation Gothenburg, Sweden

14

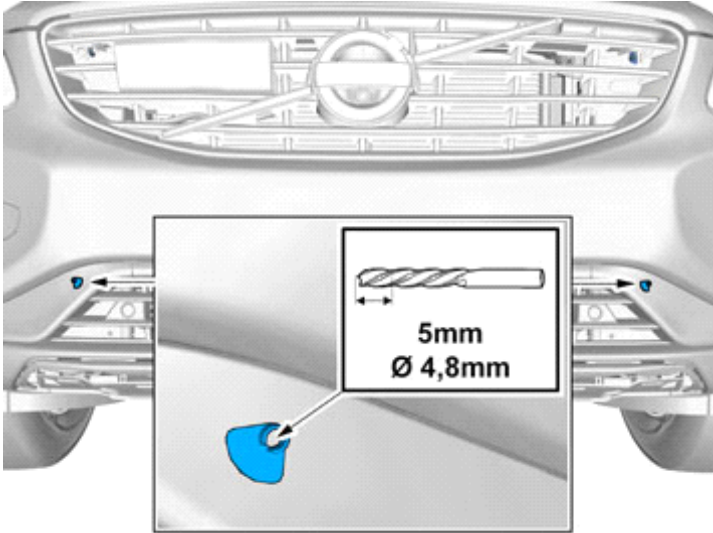

IMG-375205

15

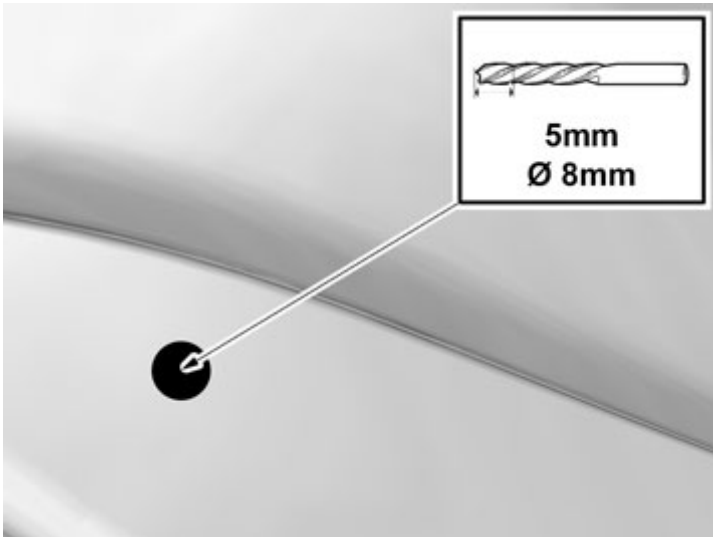

IMG-375208

Drill the holes.

16

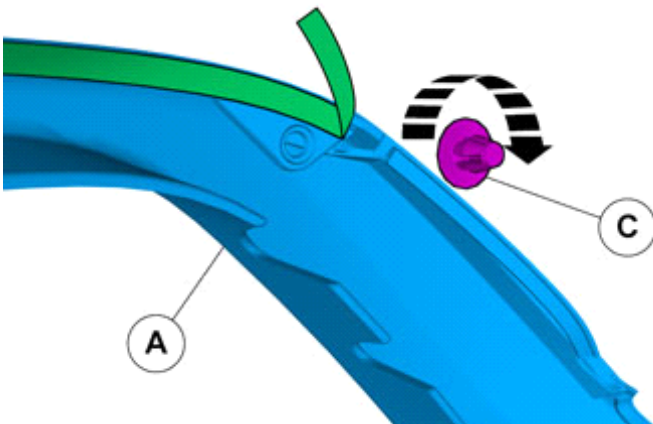

IMG-375224

Install the clips as illustrated.

Fold the protective film forward



Installation instructions, accessories

Volvo Car Corporation Gothenburg, Sweden

17

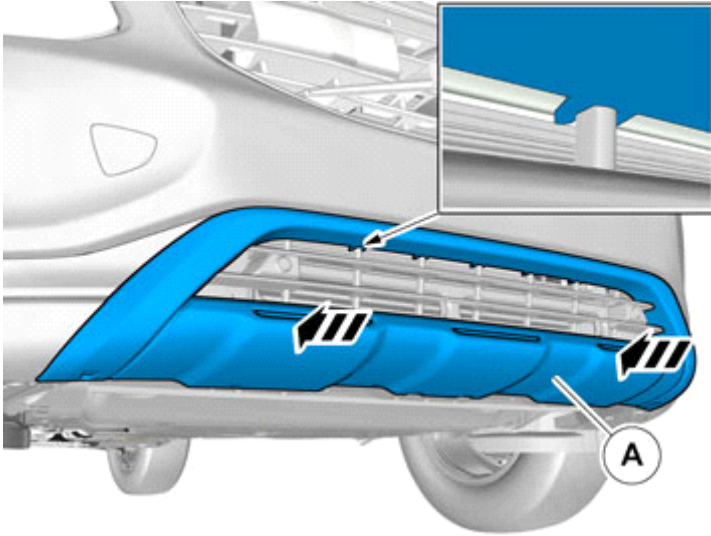

IMG-375162

18

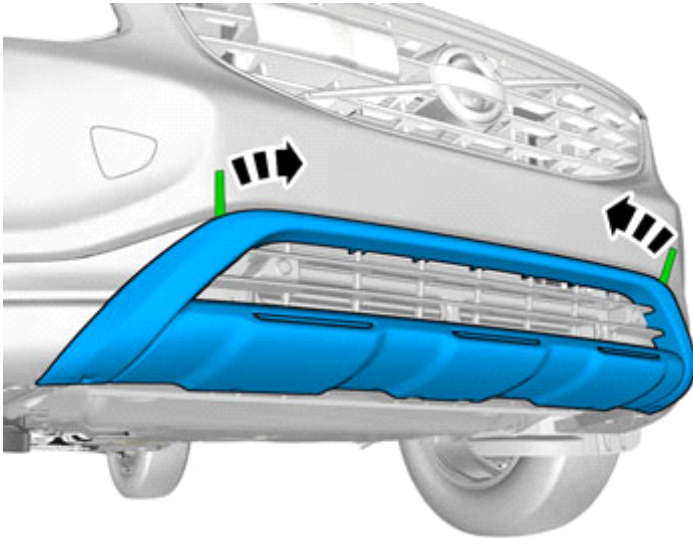

IMG-375528

Hint

Press and apply pressure to the part over the tape for at least 20 seconds.



Installation instructions, accessories

Volvo Car Corporation Gothenburg, Sweden

19

Install the screws.

Note position of components.

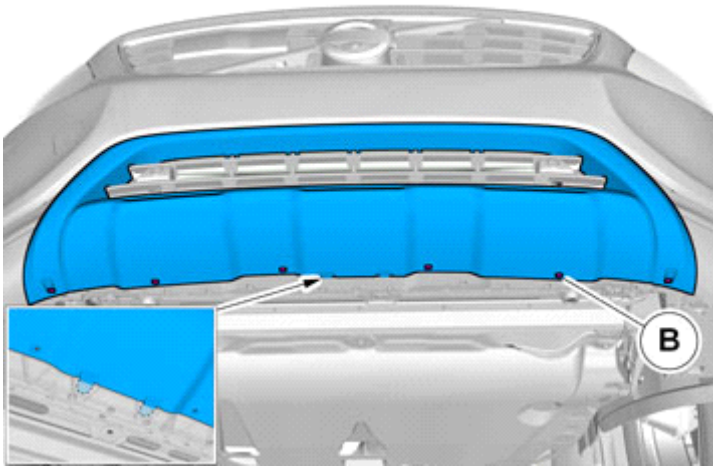

IMG-375164